

High Performance and
Overqualified Spray Nozzles for
Extrusion Vacuum Tank Spray
Technology

Extrusion Vacuum Tank Nozzle

35.
Years

Trough our continuously developing engineering research ,Mitsuda is offering high technology nozzle and spraying options that provides increasing product and surface impact quality.For all sectors working trough surface treatments such as coloring,drying,rinsing,descaling.. the best results can be achieved through using the test fit nozzles designed for thr required aplication.Mitsuda provides perfect solutions to users through its wide range of products and 35 years experience in surface technology applications. Our experied team guide you to get highest working performance through adapting continuously developing nozzle and spraying technology.



Mitsuda has established successful partnerships that are still on going through many fairs worldwide. The new technological era of virtual fair platform also enable Mitsuda to present its engineering srudies in the nozzle technology improvements.



MH 302



Assembly
MH302-1



Assembly
MH302-2

- Tangential flow design Self-cleaning,
- Clog-resistant design
- Homogeneous spray coating



MF 303



Assembly
MH303-1



Assembly
MH303-2

- Tangential flow design
- Unaffected by transient pressures
- Extremely uniform liquid distribution

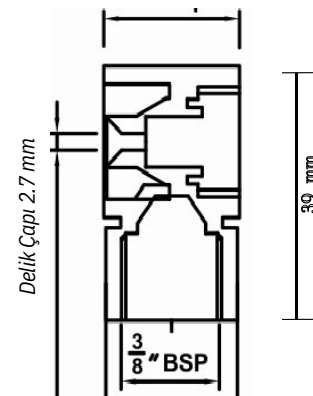
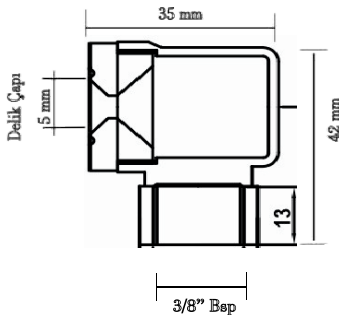
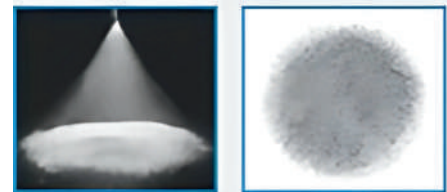
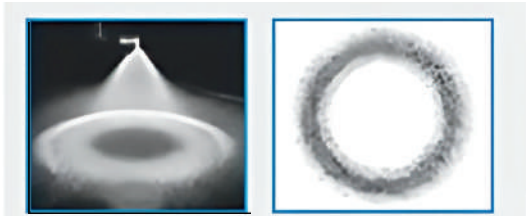

Fields of Application

- Surface Spraying Dust Control
- Pipe Cooling During Pvc/Hdpe Pipe Extrusion
- Cleaning and Washing Process
- Degreasing and Phosphating
- Foam Control for Storage Tanks

Spray angle @ 3 bar	Nozzle Code	Hole Diameter (mm)	Nozzle Flow Rate	Spray Pressure						
				0.6 bar	1.3 bar	2.0 bar	3.0 bar	4.0 bar	5.0 bar	7.0 bar
90°	MF 303	2,6	[l/min]	1.84	2.76	3.28	3.80	4.70	5.42	5.99
			[gal/min]	0.49	0.73	0.87	1.01	1.24	1.43	1.58
	MH 302	5.00	[l/min]	2.50	3.00	3.42	4.15	5.15	6.00	6.80
			[gal/min]	0.66	0.79	0.90	1.09	1.36	1.58	1.79

M1



Two Side Eyelet Clamp

- For Pipe Dia 1 inç
- 32-35.4 mm Outer Diameter BSPT Male Threads
- Termination : 1/4-3/8-1/2
- Drill Dia: 12 mm STD

M2



Single Side Eyelet

- For Pipe Dia 1 inç
- 32-35.4 mm Outer Diameter BSPT Male Threads
- Termination : 1/4-3/8-1/2
- Drill Dia: 12 mm STD
- For Pipe Dia 3/4
- 25-27.5 mm Outer Diameter BSPT Male Threads
- Termination : 1/4-3/8-1/2
- Drill Dia : 12 mm STD
- For Pipe Dia : 1-1/4
- 40-42.5 mm Outer Diameter BSPT Male Threads
- Termination : 1/4-3/8-1/2
- Drill Dia : 12 mm STD

M3



Clamp Eyelet Clamp

- For Pipe Dia 1 inç
- 32-35.4 mm Outer Diameter BSPT Male Threads
- Termination : 1/4-3/8-1/2
- Drill Dia: 12 mm STD
- For Pipe Dia 3/4
- 25-27.5 mm Outer Diameter BSPT Male Threads
- Termination : 1/4-3/8-1/2
- Drill Dia : 12 mm STD
- For Pipe Dia : 1-1/4
- 40-42.5 mm Outer Diameter BSPT Male Threads
- Termination : 1/4-3/8-1/2
- Drill Dia : 12 mm STD

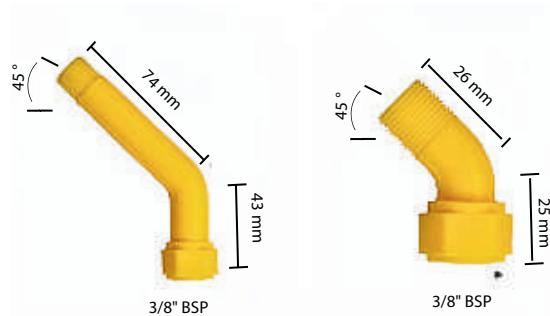

- Bend Pipe Long
- Bend Pipe Short

NOTE: (For Eyelet Clamp) Clip Eyelet Clamps are for 7.50 mm drilled holes. STD

- Clamp Material : Polypropolan



The Criteria for Nozzle Select on



the nozzle will be detaches by e 90° twist without chancing the position of the nozzle base

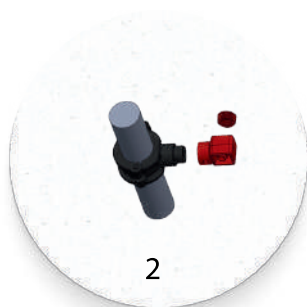

the spray direction is precisely fixed.the worn out nozzle can be replaced.

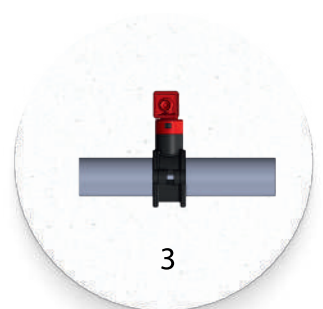

after re-assembly the spray direction remain exatly in the former position

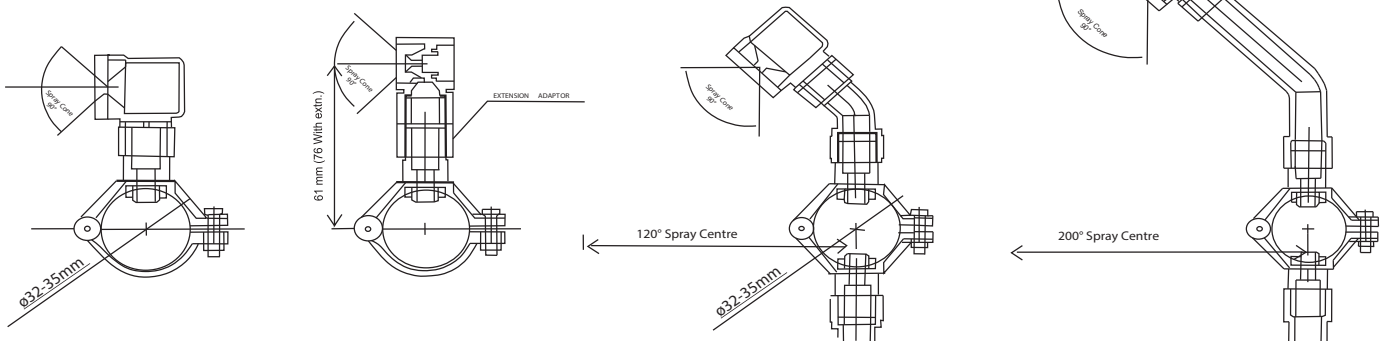

Hollowcone And Tangential flow Type Nozzles In Vacuum and Cooling System

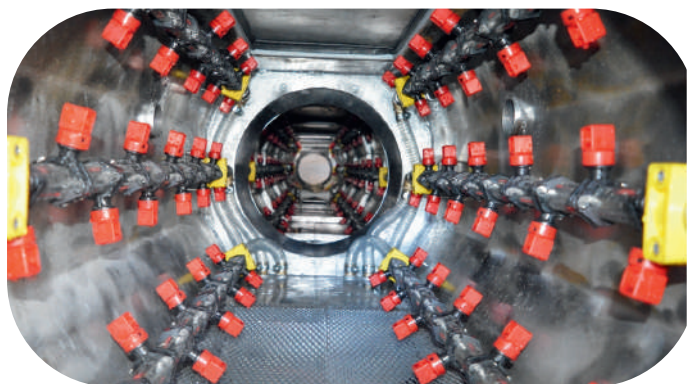

A Detailed Look Pipe Vacuum Tank Spray Nozzles

• Pipe vacuum tank spray nozzles are specially designed spraying equipment frequently used in the production of plastic pipes. These nozzles play a critical role in the cooling and shaping of pipes within a vacuum environment.

Operating Principle

• **Coolant Spraying** : The spray nozzles, positioned inside the tank, atomize the coolant (usually water) into a fine mist and spray it onto the pipe's surface. This spraying process ensures rapid and even cooling of the pipe.

• **Cooling and Shaping** : The coolant reduces the pipe's temperature, causing it to solidify and assume the desired shape. The vacuum applies uniform pressure to the outer surface of the pipe, contributing to a smooth surface finish.



Easy Change of Nozzle

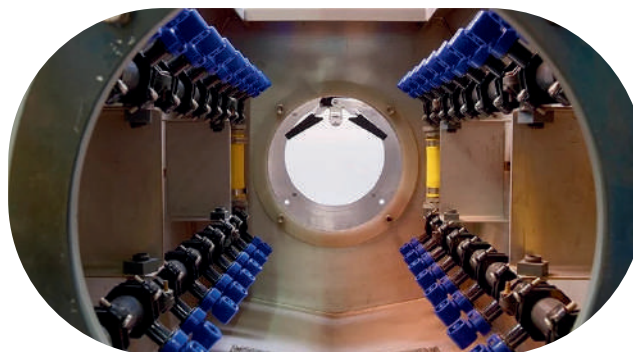

Advantages

- Rapid and Even Cooling** : Ensures quick and uniform cooling across the entire pipe surface.
 - High-Quality Product** : Improves surface quality and dimensional tolerances of the product.
 - Energy Efficiency** : Optimizes the cooling process, reducing energy consumption.
 - Automation Compatibility** : Can be easily integrated into automated production processes.
- Summary: Pipe vacuum tank spray nozzles are indispensable in modern plastic pipe manufacturing. These nozzles enable high-quality and efficient production.



Fields of Application

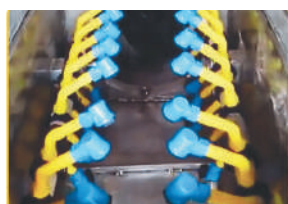



M.HAWK.01.16.01.53



M.HAWK.01.14.01.53



M.HAWK.02.16.01.53



M.HAWK.02.14.01.53



M.HAWK.02.11.01.53



M1.676.XXX.53.30.01



M.092.080.53.AX.01



M.067.630.53.40.00



M6.422



M46.460



M4.490



M2.632



M3.686

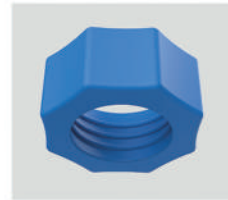

M.092.80.53.00.02

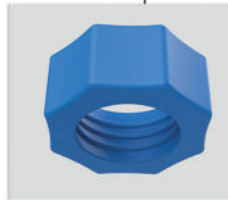

M.092.80.53.00.02

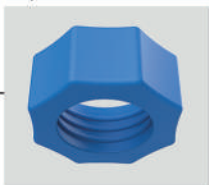

M.092.080.53.00.02

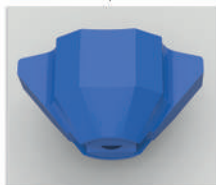

M7.676.XXX.E8.40

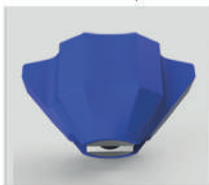

M7.676.XXX.8X.40

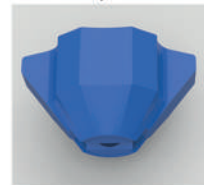

M7.676.XXX.E8.40

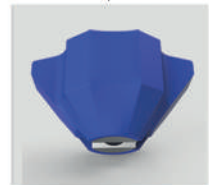

M7.676.XXX.8X.40



MITSUDA®

Spray Nozzle

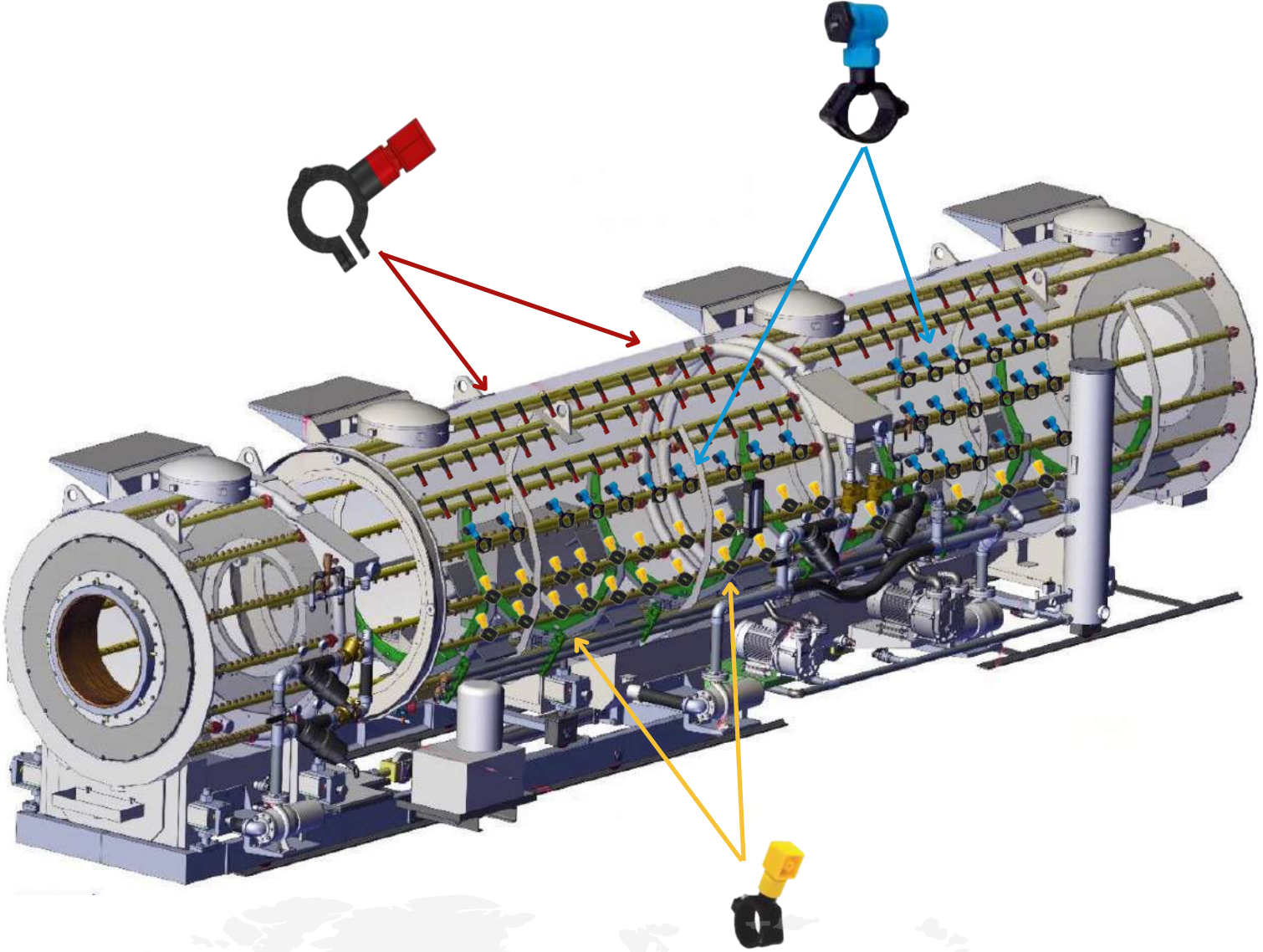

Head Office: Mimar Sinan Mah. Yedpa Tic. Mrk. F Cad. No:143 Ataşehir/ İSTANBUL
T: +90 216 471 09 87 F: +90 216 471 09 94



info@mitsuda.com.tr



+90 507 227 28 98



www.extrusionvacuumtanknozzle.com

www.mitsuda.com.tr